

INSTRUCTION MANUAL

MA882, MA883, MA884, MA885

Digital Wine Refractometers





THANK YOU for choosing Milwaukee Instruments!

This instruction manual will provide you the necessary information for correct use of the meters.

All rights are reserved. Reproduction in whole or in part is prohibited without the written consent of the copyright owner, Milwaukee Instruments Inc., Rocky Mount, NC 27804 USA.

TABLE OF CONTENTS

1. FUNCTIONAL DESCRIPTION 5

2. GENERAL DESCRIPTION 8

3. SPECIFICATIONS 9

4. PRINCIPLE OF OPERATION 10

5. MEASUREMENT UNITS 11

6. MEASUREMENT GUIDELINES 13

7. CALIBRATION PROCEDURE 14

8. MEASUREMENT PROCEDURE 16

9. CHANGING MEASUREMENT UNIT (**MA884** & **MA885**) 18

10. CHANGING TEMPERATURE UNIT 20

11. CHANGING POTENTIAL ALCOHOL CONVERSION FACTOR
 (**MA884** only) 21

12. MAKING A STANDARD %BRIX SOLUTION 22

13. ERROR MESSAGES 23

14. BATTERY REPLACEMENT 25

CERTIFICATION 26

RECOMMENDATION 26

WARRANTY 26

4 MA882, MA883, MA884, MA885 Digital Wine Refractometers

Remove the instrument from the packing materials and examine carefully to ensure no damage has occurred during shipping. If any damage has occurred, notify your Dealer.

Each instrument is supplied with:

- 9 V battery
- Instruction manual

Note: Save all packing material until you are sure that the instrument functions correctly. A defective instrument must be returned in its original packing.

1. FUNCTIONAL DESCRIPTION

DISPLAY

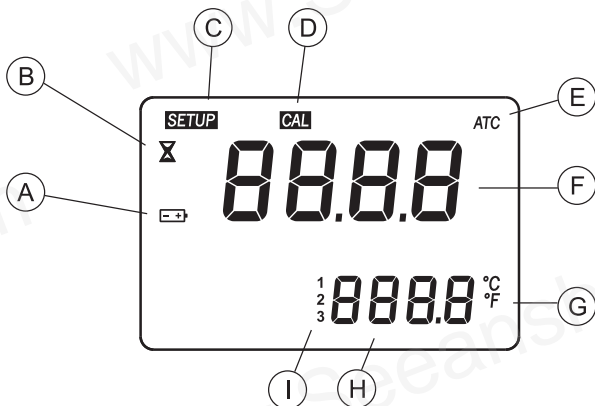

- A. BATTERY STATUS ICON (BLINKS WHEN LOW BATTERY CONDITION DETECTED)
- B. MEASUREMENT IN PROGRESS TAG
- C. SETUP: FACTORY CALIBRATION TAG
- D. CAL: CALIBRATION TAG
- E. AUTOMATIC TEMPERATURE COMPENSATION (BLINKS WHEN TEMPERATURE EXCEEDS 10-40 °C / 50-104 °F RANGE)
- F. PRIMARY DISPLAY (DISPLAYS MEASUREMENT AND ERROR MESSAGES)
- G. TEMPERATURE UNITS
- H. SECONDARY DISPLAY (DISPLAYS TEMPERATURE MEASUREMENTS; WHEN BLINKING, TEMPERATURE HAS EXCEEDED OPERATION RANGE: 0-80 °C / 32-176 °F)
- I. RANGE INDICATOR (**MA884** and **MA885**)

FRONT PANEL

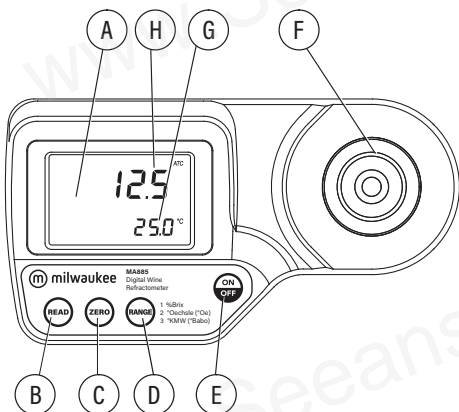
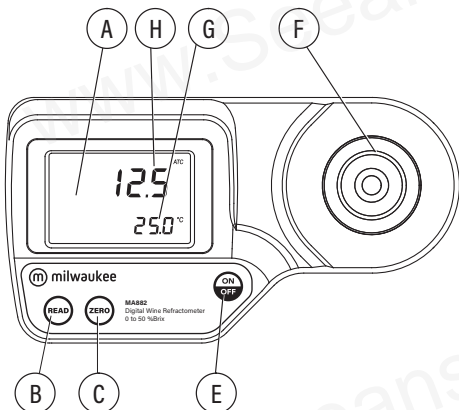

- A. LIQUID CRYSTAL DISPLAY (LCD)
- B. READ KEY (USER MEASUREMENT)
- C. ZERO KEY (USER CALIBRATION)
- D. RANGE KEY (**MA884** and **MA885**)
- E. ON/OFF
- F. STAINLESS STEEL SAMPLE WELL AND PRISM
- G. SECONDARY DISPLAY
- H. PRIMARY DISPLAY

BOTTOM

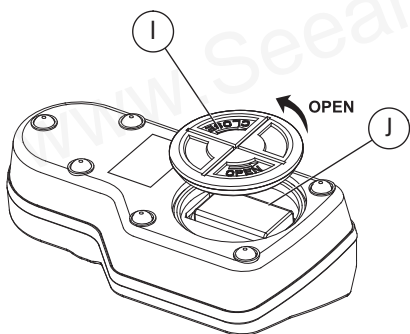

I. BATTERY COVER

J. BATTERY COMPARTMENT

2. GENERAL DESCRIPTION

SIGNIFICANCE OF USE

Thank you for choosing Milwaukee. This instruction manual will provide you the necessary information for correct use of the meter. The **MA882**, **MA883**, **MA884** and **MA885** are optical instruments that are based on the measurement of the refractive index of a solution. The measurement of refractive index is simple and quick and provides the vintner an accepted method for sugar content analysis. Samples are measured after a simple user calibration with deionized or distilled water. Within seconds the instrument measures the refractive index of the grape. This digital refractometers eliminate the uncertainty associated with mechanical refractometers and are easily portable for measurements in the field.

The four instruments utilize internationally recognized references for unit conversion and temperature compensation.

MA882	measures	%Brix
MA883	measures	°Baumé
MA884	measures	%Brix Potential Alcohol (% vol)
MA885	measures	%Brix °Oechsle (°Oe) °KMW (°Babo)

Temperature (in °C or °F) is displayed simultaneously with the measurement on the large dual level display along with icons for Low Power and other helpful message codes.

Key features include:

- Dual-level LCD
- Automatic Temperature Compensation (ATC)
- Easy setup and storage
- Battery operation with Low Power indicator
- Automatically turns off after 3 minutes of non-use
- Single-point calibration with distilled or deionized water
- Waterproof models offers IP65 waterproof protection
- Quick, precise results readings are displayed in approximately 1.5 seconds
- Small sample size as small as 2 metric drops.

3. SPECIFICATIONS

MA882

Range:	0 to 50 %Brix	0 to 80°C (32 to 176°F)
Resolution:	0.1 %Brix	0.1°C (0.1°F)
Accuracy:	±0.2 %Brix	±0.3°C (±0.5°F)

MA883

Range:	0 to 28 °Baumé	0 to 80°C (32 to 176°F)
Resolution:	0.1 °Baumé	0.1°C (0.1°F)
Accuracy:	±0.1 °Baumé	±0.3°C (±0.5°F)

MA884

Range:	0 to 50 %Brix 0 to 25 % v/v Potential Alcohol	0 to 80°C (32 to 176°F)
Resolution:	0.1 %Brix 0.1 %v/v Potential Alcohol	0.1°C (0.1°F)
Accuracy:	±0.2 %Brix ±0.2 % v/v Potential Alcohol	±0.3°C (±0.5°F)

MA885

Range:	0 to 50 %Brix 0 to 230 °Oechsle 0 to 42 °KMW	0 to 80°C (32 to 176°F)
Resolution:	0.1 %Brix 1 °Oechsle 0.1 °KMW	0.1°C (0.1°F)
Accuracy:	±0.2 %Brix ±1 °Oechsle ±0.2 °KMW	±0.3°C (±0.5°F)

Common Specifications

Light Source	Yellow LED
Measurement Time	Approximately 1.5 seconds
Minimum Sample Volume	100 µL (cover prism totally)
Sample Cell	Stainless Steel ring and flint glass prism
Temperature Compensation	Automatic between 10 and 40 °C (32 to 104 °F)
Case Material	ABS
Enclosure Rating	IP 65
Battery Type/Life	1 x 9 volt AA batteries / 5000 readings
Auto-Shut off	After 3 minutes of non-use
Dimensions	19.2 x 10.2 x 6.7 cm (7.5 x 4 x 2.6")
Weight	420 g (14.8 oz.).

4. PRINCIPLE OF OPERATION

%Brix, °Baumé, °Oechsle, °KMW and % potential alcohol determinations are made by measuring the refractive index of a solution. Refractive Index is an optical characteristic of a substance and the number of dissolved particles in it. Refractive Index is defined as the ratio of the speed of light in empty space to the speed of light in the substance. A result of this property is that light will “bend”, or change direction, when it travels through a substance of different refractive index. This is called refraction.

When passing from a material with a higher to lower refractive index, there is a critical angle at which an incoming beam of light can no longer refract, but will instead be reflected off the interface. The critical angle can be used to easily calculate the refractive index according to the equation:

$$\sin(\theta_{\text{critical}}) = n_2 / n_1$$

Where n_2 is the refractive index of the lower-density medium; n_1 is the refractive index of the higher-density medium.

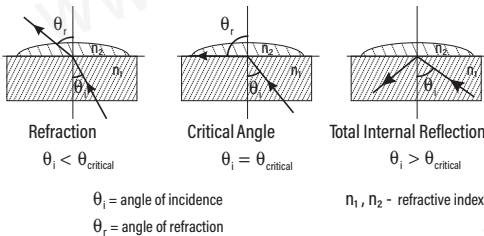

In the **MA882**, **MA883**, **MA884** and **MA885** refractometers, light from an LED passes through a prism in contact with the sample. An image sensor determines the critical angle at which the light is no longer refracted through the sample.

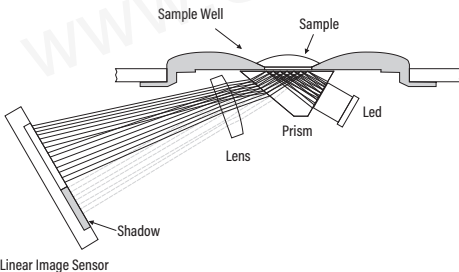

Specialized algorithms then apply temperature compensation to the measurement and convert this refractive index to the model specific measurement unit.

5. MEASUREMENT UNITS

MA882, MA883, MA884 and **MA885** measure sugar content in several units to meet the differing requirements found in the wine industry.

MA882, MA884 and **MA885** convert the refractive index of the sample to sucrose concentration in units of percent by weight, %Brix (also referred to as °Brix). The conversion used is based on the ICUMSA Methods Book (International Commission for Uniform Methods of Sugar Analysis). Since the majority of sugar in grape juice is fructose and glucose and not sucrose, the reading is sometimes referred to as "Apparent Brix".

MA883 has units of °Baumé. The °Baumé scale is based on density and was originally designed to measure the mass of sodium chloride in water. °Baumé is used in wine making to measure the sugar in must. The **MA883** converts the %Brix reading to °Baumé based on the table found in the Official Methods of Analysis of AOAC International, 18th Edition. 1 °Baumé is approximately equal to 1.8 %Brix, and 1 °Baumé is roughly equivalent to 1 % alcohol when the wine is fully fermented.

In addition to %Brix, **MA885** includes two other scales used in the wine industry: °Oechsle and °KMW.

°Oechsle (°Oe) is mainly used in the German, Swiss and Luxemburgish winemaking industry to measure the sugar content of must. The °Oe scale is based on specific gravity at 20°C (SG20/20) and is the first 3 digits following the decimal point. 1 °Oe is roughly equal to 0.2 %Brix.

$$^{\circ}\text{Oe} = [(\text{SG}20/20) - 1] \times 1000$$

°Klosterneuburger Mostwaage (°KMW) is used in Austria to measure the sugar content of must. °KMW is related to °Oe by the following equation:

$$^{\circ}\text{Oe} = ^{\circ}\text{KMW} \times [(0.022 \times ^{\circ}\text{KMW}) + 4.54]$$

1 °KMW is roughly equivalent to 1 %Brix or 5 °Oe. °KMW is also known as °Babo.

In addition to %Brix, **MA884** also has a second scale that estimates the alcohol content in the finished wine in (% vol/vol). This is known as "potential" or "probable" alcohol since the conversion

between sugar and alcohol depends on many factors such as the type of grapes, the grape maturity, the growing region and yeast fermentation efficiency and temperature.

Since no fixed conversion factor is universally applicable, **MA884** allows the user to tailor the instrument to their specific needs based on their experience.

The first conversion is based on the %Brix value, with an adjustable conversion factor anywhere between 0.50 and 0.70 (0.55 is a common value).

$$\text{Potential alcohol (\% v/v)} = (0.50 \text{ to } 0.70) \times \% \text{Brix}$$

One drawback of the above equation is that it does not take into account the nonfermentable sugars and extract.

A second equation was also added that takes these factors into account and can give a more accurate estimate of the alcohol content in the finished wine. This conversion is named "C1" on the meter, and uses the following equation:

$$\text{Potential Alcohol (\% v/v)} = 0.059 \times [(2.66 \times \text{°Oe}) - 30] \quad (\text{C1})$$

6. MEASUREMENT GUIDELINES

- Handle instrument carefully. Do not drop.
- Do not immerse instrument under water.
- Do not spray water to any part of instrument except the "sample well" located over the prism.
- The instrument is intended to measure grape/wine solutions. Do not expose instrument or prism to solvents that will damage it. This includes most organic solvents and extremely hot or cold solutions.
- Particulate matter in a sample may scratch the prism. Absorb sample with a soft tissue and rinse sample well with deionized or distilled water between samples.
- Use plastic pipettes to transfer all solutions. Do not use metallic tools such as needles, spoons or tweezers as these will scratch the prism.
- Cover sample well with hand if measuring in direct sun.

7. CALIBRATION PROCEDURE

Calibration should be performed daily, before measurements are made, when the battery has been replaced, between a long series of measurements, or if environmental changes have occurred since the last calibration.

1. Press the **ON/OFF** key, then release. Two instrument test screens will be displayed briefly; all LCD segments followed by the percentage of remaining battery life. When the LCD displays dashes, the instrument is ready.

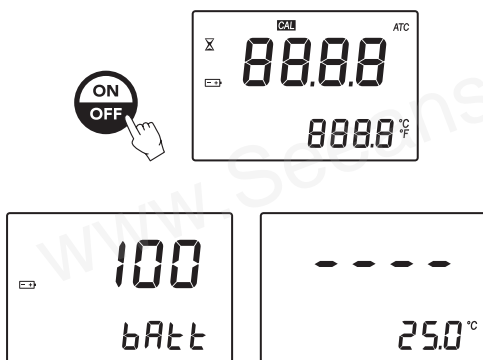

2. Using a plastic pipette, fill the sample well with distilled or deionized water. Make sure the prism is completely covered.

Note: If the ZERO sample is subject to intense light such as sunlight or another strong source, cover the sample well with your hand or other shade during the calibration.

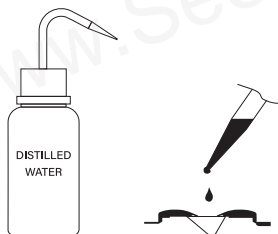

3. Press the **ZERO** key. If no error messages appear, your unit is calibrated. (For a description of error messages see ERROR MESSAGES section).

Note: The 0.0 screen will remain until a sample is measured or the instrument is turned off.

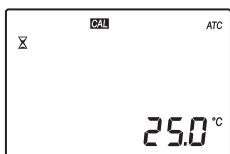

4. Gently absorb the ZERO water standard with a soft tissue. Use care not to scratch the prism surface. Dry the surface completely. The instrument is ready for sample measurement.

Note: If instrument is turned off the calibration will not be lost.



8. MEASUREMENT PROCEDURE

Verify the instrument has been calibrated before taking measurements.

For **MA884** and **MA885** select the desired measurement unit (see CHANGING MEASUREMENT UNIT (**MA884** & **MA885**) section).

1. Wipe off prism surface located at the bottom of the sample well. Make sure the prism and sample well are completely dry.



2. Using a plastic pipette, drip sample onto the prism surface. Fill the well completely.

Note: If the temperature of the sample differs significantly from the temperature of the instrument, wait approximately 1 minute to allow thermal equilibration.



3. Press the **READ** key. The results are displayed in unit of interest.

Note: The last measurement value will be displayed until the next sample is measured or the instrument is turned off. Temperature will be continuously updated.

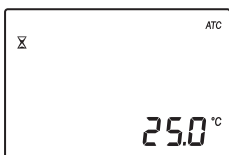

Note: The "ATC" tag blinks and automatic temperature compensation is disabled if the temperature exceeds the 0-40 °C / 32-104 °F range.

4. Remove sample from the sample well by absorbing on a soft tissue.
5. Using a plastic pipette, rinse prism and sample well with distilled or deionized water. Wipe dry. The instrument is ready for the next sample.

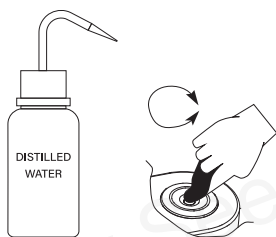

9. CHANGING MEASUREMENT UNIT (MA884 & MA885)

For **MA884** only:

1. Press the RANGE key to select measurement units of %Brix or % potential alcohol. The instrument toggles between the two measurement scales each time the key is pressed and the primary display indicates "bri" for %Brix or "P.Alc" for potential alcohol. When the instrument displays the screen with 4 dashes, the instrument is ready for measurement. A number on the display indicates the selected unit: "1" denotes %Brix and "2" denotes potential alcohol as indicated on the instrument cover.
2. The potential alcohol scale also indicates the conversion factor chosen for the potential alcohol reading. See CHANGING POTENTIAL ALCOHOL CONVERSION FACTOR to change the current factor.

Note: When changing ranges the presently configured conversion factor will be displayed in the lower display. (See FUNCTIONAL DESCRIPTION)

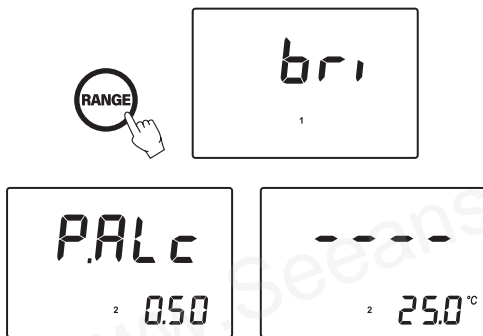

For **MA885** only:

1. Press the **RANGE** key to select measurement units %Brix, °Oechsle (°Oe) or °KMW (°Babo). The instrument toggles between the three scales each time the key is pressed and the primary display indicates "bri" for %Brix, "OE" for °Oechsle or "bAbo" for °KMW. When the instrument displays the screen with 4 dashes the instrument is ready for measurement. A number on the display indicates the selected unit: "1" denotes

%Brix, "2" denotes °Oe and "3" denotes °KMW as indicated on the instrument cover.

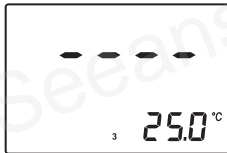
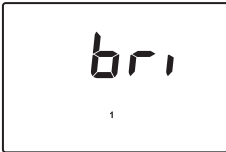

10. CHANGING TEMPERATURE UNIT

To change the temperature measurement unit from Celsius to Fahrenheit (or vice versa), follow this procedure.

1. Press and hold the **ON/OFF** key continuously for approximately 8 seconds. The LCD will display the "all segment" screen followed by a screen with the model number on the primary display and the version number on the secondary display. Continue pressing the **ON/OFF** key.



8 seconds



2. While continuing to hold the **ON/OFF** key, press the **ZERO** key. The temperature unit will change from °C to °F or vice versa.



°C or °F

11. CHANGING POTENTIAL ALCOHOL CONVERSION FACTOR (MA884 only)

To change the potential alcohol conversion factor, follow this procedure.

1. Press and hold **ON/OFF** key continuously for approximately 8 seconds. The LCD will display all segments screen followed by a screen with the model number on the primary display and the version number on the secondary display. Continue pressing the **ON/OFF** key.

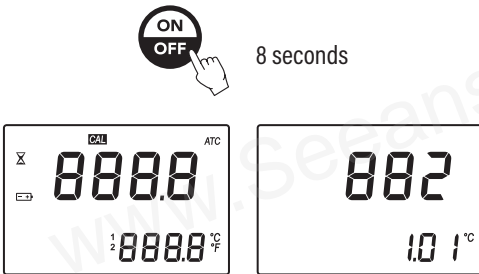

2. While continuing to hold **ON/OFF**, press the **RANGE** key. The LCD will show the current conversion factor on the primary display and "**P.ALc**" on the secondary display. Continue holding the **ON/OFF** key. Press the **ZERO** key to increase this number. The number will continually increase until "**0.70**" is reached then wrap back to "**C1**". The user selectable conversion range is 0.50 to 0.70. C1 stands for "curve 1" (see MEASUREMENT UNITS). When you reach the conversion factor you desire release the **ON/OFF** key. The new conversion factor will be used.

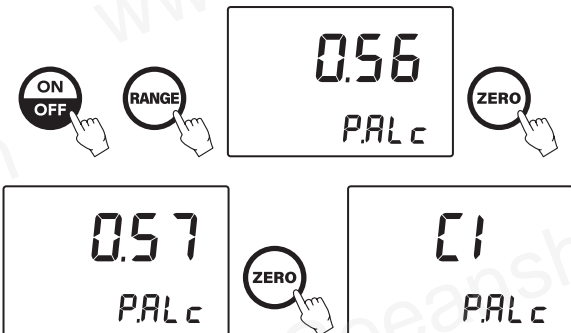

12. MAKING A STANDARD %BRIX SOLUTION









- To make a Brix Solution, follow the procedure below:
- Place container (such as a glass vial or dropper bottle that has a cover) on an analytical balance.
- Tare the balance.
- To make an X BRIX solution weigh out X grams of high purity Sucrose (CAS #: 57-50-1) directly into the container.
- Add distilled or deionized water to the container so the total weight of the solution is 100 g.

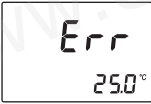

Note: Solutions above 60 %Brix need to be vigorously stirred or shaken and heated in a water bath. Remove solution from bath when sucrose has dissolved. The total quantity can be scaled proportionally for smaller containers but accuracy may be sacrificed.

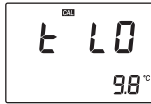
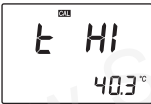
Example with 25 %Brix:

%Brix	g Sucrose	g Water	g Total
25	25.000	75.000	100.000

13. ERROR MESSAGES

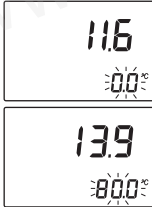
Error Code	Description	
Err		<p>General failure. Cycle power to instrument. If instrument still has error, contact Milwaukee.</p>
LO Primary display		<p>Sample is reading lower than the 0 % standard used for meter calibration.</p>
HI Primary display		<p>Sample exceeds maximum measurement range.</p>
LO Primary display CAL segment ON		<p>Wrong calibration used to zero instrument. Use deionized or distilled water. Press ZERO.</p>
HI Primary display CAL segment ON		<p>Wrong calibration used to zero instrument. Use deionized or distilled water. Press ZERO.</p>
t LO Primary display CAL segment ON		<p>Temperature exceeds ATC low limit (10 °C) during calibration.</p>
t HI Primary display CAL segment ON		<p>Temperature exceeds ATC high limit (40 °C) during calibration.</p>
Air		<p>Prism surface insufficiently covered.</p>
ELt		<p>Too much external light for measurement. Cover sample well with hand.</p>
nLt		<p>LED light is not detected. Contact Milwaukee.</p>

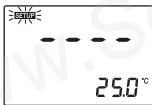
<p>Battery segment blinking</p>		<p><5% of battery life is remaining.</p>
<p>Temperature values are blinking 0.0°C or 80.0°C</p>		<p>Temperature measurement out of sampling range (0.0 to 80.0°C).</p>
<p>ATC segment blinking</p>		<p>Outside temperature compensation range (10 to 40°C).</p>
<p>SETUP segment blinking</p>		<p>Factory calibration lost. Contact Milwaukee.</p>

14. BATTERY REPLACEMENT

To replace the instrument's battery, follow these steps:

- Turn the instrument OFF by pressing the **ON/OFF** key.



- Turn instrument upside down and remove the battery cover by turning it counterclockwise.

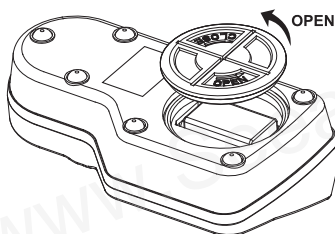

- Extract the battery from its location.
- Replace with fresh 9V battery making certain to observe polarity.
- Insert the back battery cover and fasten it by turning clockwise to engage.

CERTIFICATION

Milwaukee Instruments conform to the CE European Directives.



Disposal of Electrical & Electronic Equipment. Do not treat this product as household waste. Hand it over to the appropriate collection point for the recycling of electrical and electronic equipment.

Disposal of waste batteries. This product contains batteries. Do not dispose of them with other household waste. Hand them over to the appropriate collection point for recycling.



Please note: proper product and battery disposal prevents potential negative consequences for human health and the environment. For detailed information, contact your local household waste disposal service or go to www.milwaukeeinstruments.com (US only) or www.milwaukeeinst.com.

RECOMMENDATION

Before using this product, make sure it is entirely suitable for your specific application and for the environment in which it is used. Any modification introduced by the user to the supplied equipment may compromise the meter's performance. For your and the meter's safety do not use or store the meter in hazardous environment. To avoid damage or burn, do not perform any measurement in microwave ovens.

WARRANTY

These instruments are warranted against defects in materials and manufacturing for a period of 2 years from the date of purchase. Electrodes and Probes are warranted for 6 months. This warranty is limited to repair or free of charge replacement if the instrument cannot be repaired. Damage due to accidents, misuse, tampering or lack of prescribed maintenance is not covered by warranty. If service is required, contact your local Milwaukee Instruments Technical Service. If the repair is not covered by the warranty, you will be notified of the charges incurred. When shipping any meter, make sure it is properly packaged for complete protection.

om

www.Seeanshop

om

www.Seeanshop

om

www.Seeanshop

om

www.Seeanshop

Milwaukee Instruments reserves the right to make improvements in design, construction and appearance of its products without advance notice.

THANK YOU FOR CHOOSING



Sales and Technical Service Contacts:

Milwaukee Electronics Kft.
Alsó-kikötő sor 11C
H-6726 Szeged - HUNGARY
tel: +36 62 428 050
fax: +36 62 428 051
www.milwaukeeinst.com
e-mail: sales@milwaukeeinst.com

Milwaukee Instruments, Inc.
2950 Business Park Drive
Rocky Mount, NC 27804 USA
tel: +1 (252) 443-3630
fax: +1 (252) 443-1937
www.milwaukeeinstruments.com
e-mail: sales@milwaukeeinstruments.com

MANMA882